

一般通用继电器 LYJ

相关信息	商品选择	792
	共通注意事项	804
	技术指南	915
	用语说明	938

电弧屏障装备 高绝缘强度(2,000 VAC)

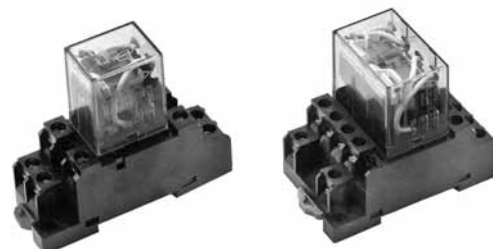





⚠ 详情请参阅804页的「共通注意事项」。



种类

继电器

接点形式	插入/焊接端子 	带指示灯插入/焊接端子 	PCB端子 	上端安装插入/焊接端子 
SPDT	LY1J	- -	LY1-0J	- -
DPDT	LY2J	LY2NJ	LY2-0J	LY2FJ
3PDT	LY3J	LY3NJ	- -	LY3FJ
4PDT	LY4J	LY4NJ	- -	LY4FJ

注. 订货时, 在型号编号上加上额定线圈电压, 额定线圈电压见线圈额定值表。

例: LY2J, 6VAC
└── 额定线圈电压

附件(另售)

插座及继电器保持夹子

继电器	前端连接插座		后端连接插座			
	DIN导轨/螺丝端子	夹子	焊接端子	夹子	PCB端子	夹子
SPDT	PTF08A	PYC-A1	PT08	PYC-P	PT08-0	PYC-P
DPDT	PTF08A-E		PT11		PT11-0	
3PDT	PTF11A		PT14		PT14-0	
4PDT	PTF14A PTF14A-E					

用于插座及继电器保持夹子的安装片

插座型号	适用于1个插座	适用于10个插座	适用于12个插座	适用于18个插座	夹子
PT08	PYP-1	- -	- -	PYP-18	PYC-1
PT11	PTP-1-3	- -	PTP-12	- -	
PT14	PTP-1	PTP-10	- -	- -	

继电器

一般继电器

技术指南

额定值/性能

线圈额定值

LY1J/LY1-0J/LY2J/LY2NJ/LY2-0J/LY2FJ

额定电压		额定值电流 (mA)		线圈电阻 (Ω)	电感 (参考值)		动作电压 (V)	复位电压 (V)	最大容许电压 (V)	消耗功率 (约)	
		50Hz	60Hz		Arm.OFF	Arm.ON					
AC	6V	214.1mA	183mA	12.2Ω	0.04H	0.08H	80% max.	30% min.	额定值电压的 110%	1.0 ~ 1.2VA(60Hz)	
	12V	106.5mA	91mA	46Ω	0.17H	0.33H					
	24V	53.8mA	46mA	180Ω	0.69H	1.30H					
	50V	25.7mA	22mA	788Ω	3.22H	5.66H					
	100/110V	11.7/12.9mA	10/11mA	3,750Ω	14.5H	24.6H					
	110/120V	9.9/10.8mA	8.4/9.2mA	4,430Ω	19.2H	32.1H					
	200/220V	6.2/6.8mA	5.3/5.8mA	12,950Ω	54.7H	94.1H					
220/240V	4.8/5.3mA	4.2/4.6mA	18,790Ω	83.5H	136H						
DC	6V	150mA		40Ω	0.16H	0.33H		10% min.			0.9W
	12V	75mA		150Ω	0.73H	1.37H					
	24V	36.9mA		650Ω	3.20H	5.72H					
	48V	18.5mA		2,600Ω	10.6H	21.0H					
	100/110V	9.1mA/10mA		11,000Ω	45.6H	86.2H					

继电器

LY3J/LY3NJ/LY3FJ

额定电压		额定值电流 (mA)		线圈电阻 (Ω)	电感 (参考值)		动作电压 (V)	复位电压 (V)	最大容许电压 (V)	消耗功率 (约)	
		50Hz	60Hz		Arm.OFF	Arm.ON					
AC	6V	310mA	270mA	6.7Ω	0.03H	0.05H	80% max.	30% min.	额定值电压的 110%	1.6 ~ 2.0VA(60Hz)	
	12V	159mA	134mA	24Ω	0.12H	0.21H					
	24V	80mA	67mA	100Ω	0.44H	0.79H					
	50V	38mA	33mA	410Ω	2.24H	3.87H					
	100/110V	14.1/16mA	12.4/13.7mA	2,300Ω	10.5H	18.5H					
	200/220V	9.0/10.0mA	7.7/8.5mA	8,650Ω	34.8H	59.5H					
DC	6V	234mA		25.7Ω	0.11H	0.21H		10% min.			1.4W
	12V	112mA		107Ω	0.45H	0.98H					
	24V	58.6mA		410Ω	1.89H	3.87H					
	48V	28.2mA		1,700Ω	8.53H	13.9H					
	100/110V	12.7mA/13mA		8,500Ω	29.6H	54.3H					

一般继电器

技术指南

LY4J/LY4NJ/LY4FJ

额定电压		额定值电流 (mA)		线圈电阻 (Ω)	电感 (参考值)		动作电压 (V)	复位电压 (V)	最大容许电压 (V)	消耗功率 (约)	
		50Hz	60Hz		Arm.OFF	Arm.ON					
AC	6V	386mA	330mA	5Ω	0.02H	0.04H	80% max.	30% min.	额定值电压的 110%	1.95 ~ 2.5VA(60Hz)	
	12V	199mA	170mA	20Ω	0.10H	0.17H					
	24V	93.6mA	80mA	78Ω	0.38H	0.67H					
	50V	46.8mA	40mA	350Ω	1.74H	2.88H					
	100/110V	22.5/25.5mA	19/21.8mA	1,600Ω	10.5H	17.3H					
	200/220V	11.5/13.1mA	9.8/11.2mA	6,700Ω	33.1H	57.9H					
DC	6V	240mA		25Ω	0.09H	0.21H		10% min.			1.5W
	12V	120mA		100Ω	0.39H	0.84H					
	24V	69mA		350Ω	1.41H	2.91H					
	48V	30mA		1,600Ω	6.39H	13.6H					
	100/110V	15mA/15.9mA		6,900Ω	32H	63.7H					

注1. 额定值电流、线圈电阻是线圈温度在+23 时的值，公差为AC额定值电流+15%、-20%，DC线圈电阻 ± 15%。

注2. 动作特性是线圈温度在+23 时的值。

注3. AC线圈电阻、电感为参考值 (60Hz时)。

注4. 根据上述值测定了功率消耗点。当晶体管驱动时，请确认漏电流并根据需要连接泄放电阻。

额定值

项目	单接点			
	1极		2,3和4极	
	阻性负载 ($\cos\phi=1$)	感性负载 ($\cos\phi=0.4$, L/R=7ms)	阻性负载 ($\cos\phi=1$)	感性负载 ($\cos\phi=0.4$, L/R=7ms)
额定负载	15A, 110VAC 10A, 220VAC 15A, 24VDC	10A, 110VAC 7A, 220VAC 7A, 24VDC	10A, 110VAC 7A, 220VAC 10A, 24VDC	7.5A, 110VAC 5A, 220VAC 5A, 24VDC
负载电流	15A		10A	
最大开关电压	250VAC, 125VDC		250VAC, 125VDC	
最大开关电流	15A		10A	
最大开关容量	2,200VA 360W	1,600VA 170W	1,600VA 240W	1,100VA 120W
最小容许负载	100mA, 5VDC			
接点材质	银合金			

注. P 水平: $= 0.1 \times 10^{-6}$ 操作, 参考值

性能

接触电阻	50mΩ以下		
动作时间	25ms以下		
复位时间	25ms以下		
操作频率	机械	18,000次/小时	
	电气	1,800次/小时	
绝缘电阻	100MΩ以上(在500VDC)		
绝缘强度	线圈与接点间	2,000VAC, 50/60 Hz 1分钟	
	与同极接点间	1,000VAC, 50/60 Hz 1分钟	
振动	破坏	10 ~ 55Hz, 1.0mm双振幅	
	故障	10 ~ 55Hz, 1.0mm双振幅	
冲击	破坏	1,000m/s ² (约100G)	
	故障	200m/s ² (约20G)	
周围环境温度	1极和2极	-25 ~ 55 (不结冰)	
	3极和4极	-25 ~ 40 (不结冰)	
周围环境湿度	35% ~ 85%RH		
寿命	机械 (开关频率18,000次/小时)	AC线圈	40,000,000次以上
		DC线圈	80,000,000次以上
	电气 (开关频率1,800次/小时)	1,3和4极	160,000次以上(额定负载下)
		2极	400,000次以上(额定负载下)
重量	1和2极	约40g	
	3极	约50g	
	4极	约70g	

注. 上述值均为初始值。

继电器

一般继电器

技术指南

特性数据

开关容量的最大值

LY1J

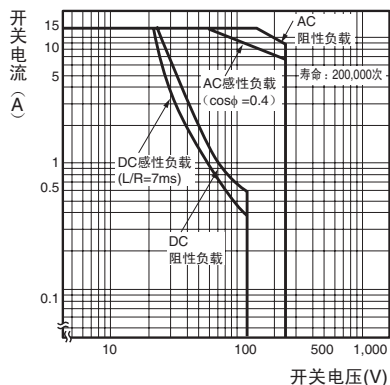

LY2J

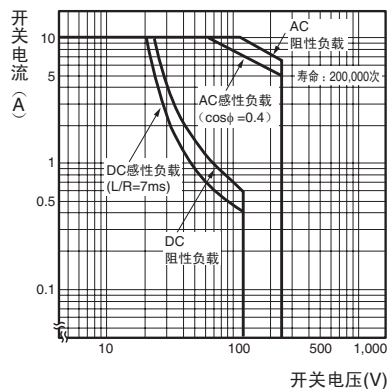

LY3J和LY4J

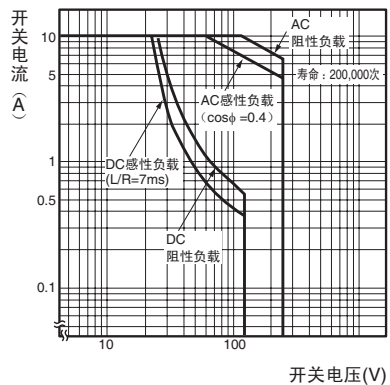

寿命

LY1J

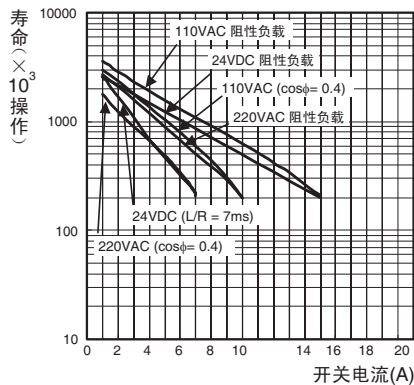

LY2J

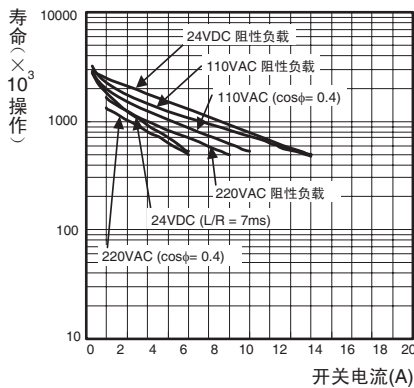

LY3J和LY4J

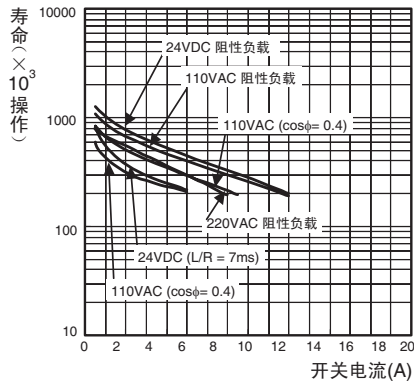

继电器

一般继电器

技术指南

外形尺寸

(单位: mm)

焊接/插入端子继电器

LY1J

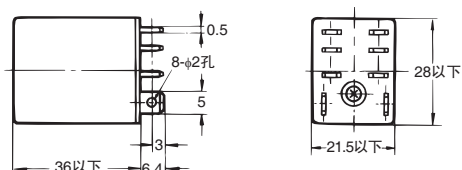
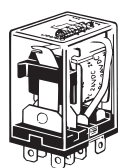

端子配置/内部连接图
(BOTTOM VIEW)

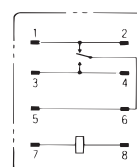

继电器

LY2J/LY2NJ

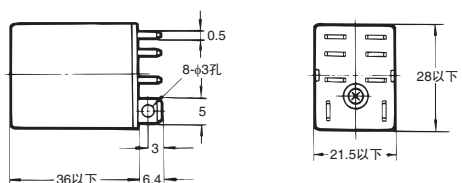
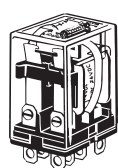

端子配置/内部连接图
(BOTTOM VIEW)

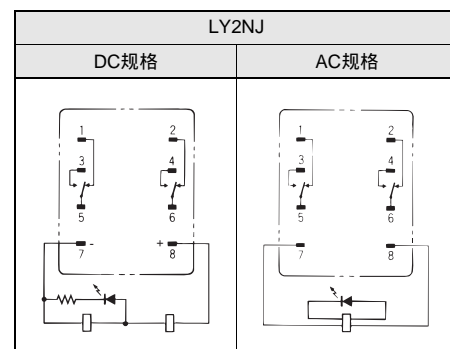
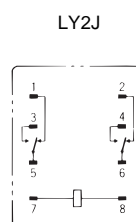

注: DC型号具有极性。

一般继电器

技术指南

LY3J/LY3NJ

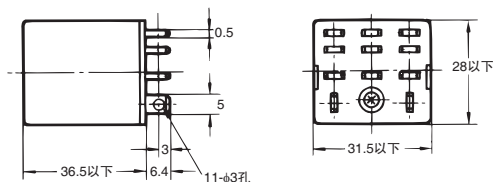
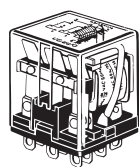

端子配置/内部连接图
(BOTTOM VIEW)

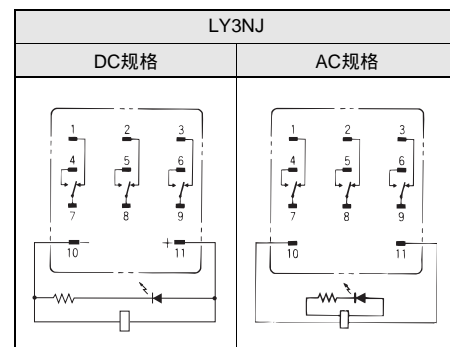
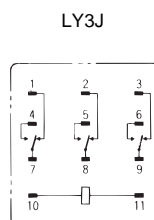

注: DC型号具有极性。

LY4J/LY4NJ

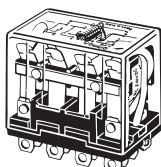

注: DC型号具有极性。

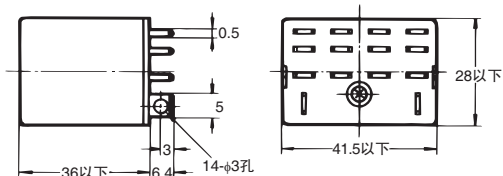

端子配置/内部连接图
(BOTTOM VIEW)

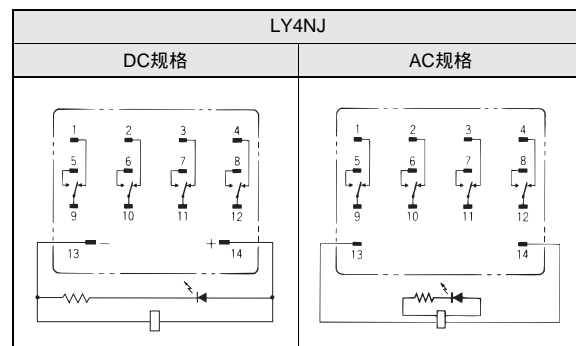
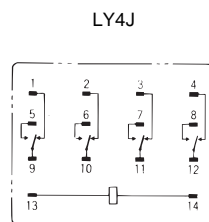

PCB端子继电器
LY1-0J/LY2-0J

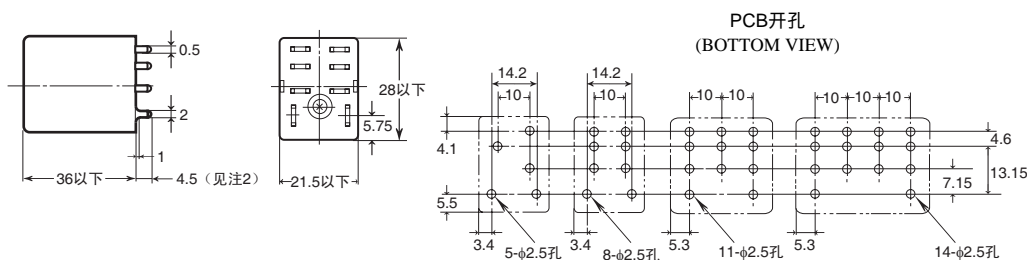
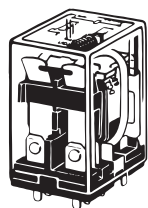

注1. 上列型号为LY2-0J。
注2. 此形状为6.4适用于LY1-0J。

注1. 上列形式的公差为0.1mm。
注2. 除端子外，LY1-0J一些部件也带电。
当安装LY1-0J到双面PC板上时应予注意。

上端安装继电器
LY2FJ

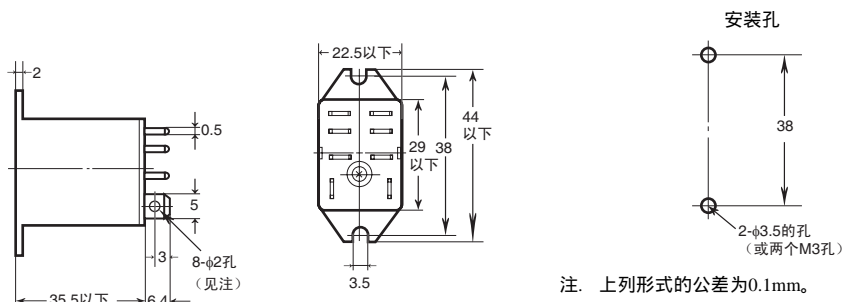
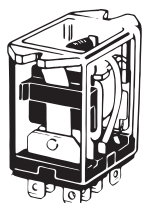

注. LY2FJ为8个φ3孔。

注. 上列形式的公差为0.1mm。

LY3FJ

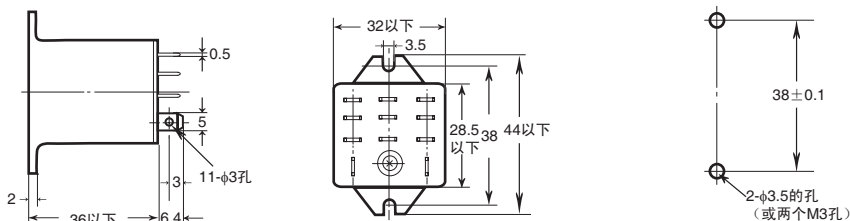
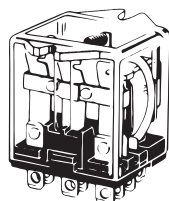

LY4FJ

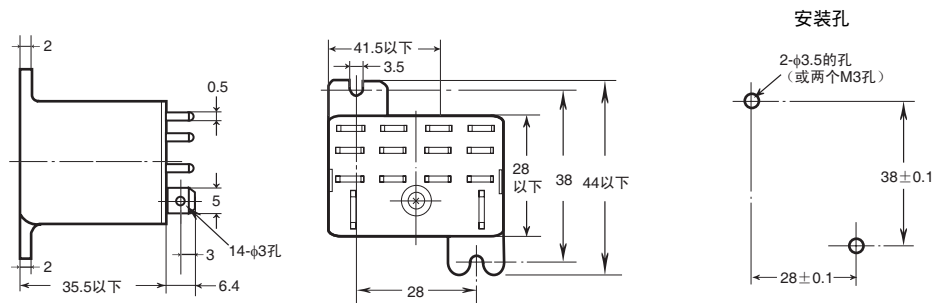
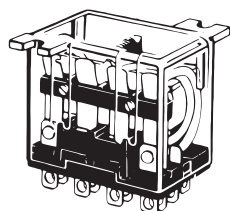

继电器

一般继电器

技术指南

附件

导轨安装插座(UL File No.E87929)(CSA Report No.LR31928)

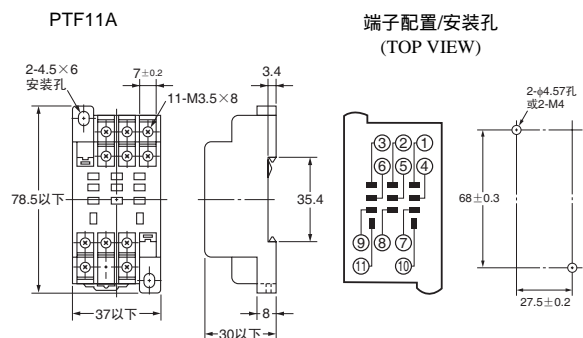
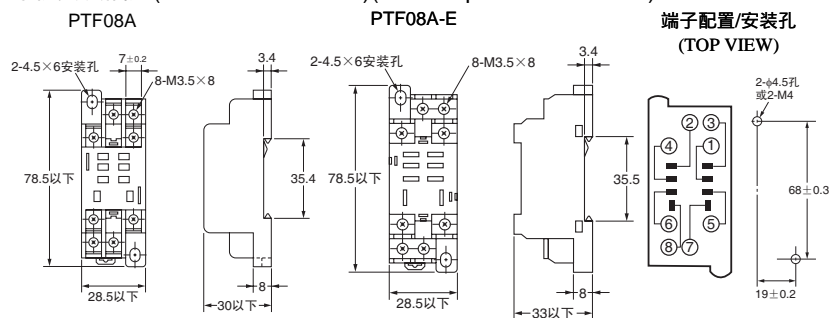

导轨安装插座(UL File No. E87929)(CSA Report No.LR31928)

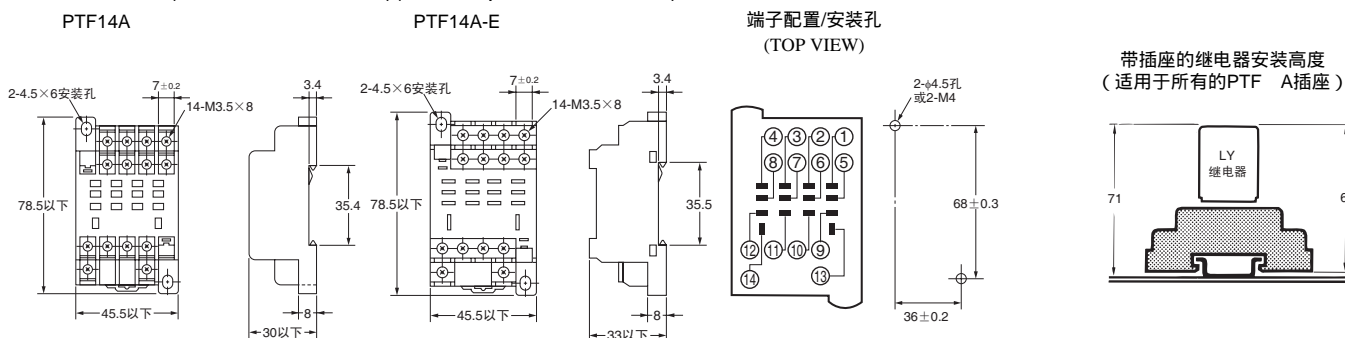

后端连接插座(UL File No. E87929)(CSA Report No.LR31928)

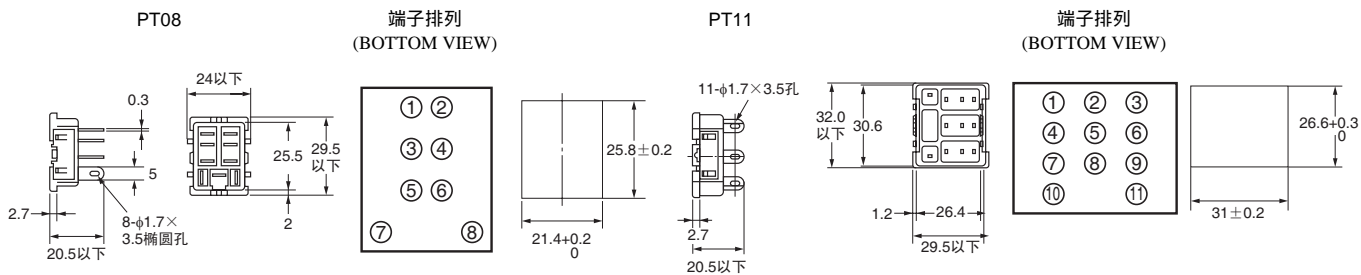

后端连接插座(UL File No. E87929)(CSA Report No.LR31928)

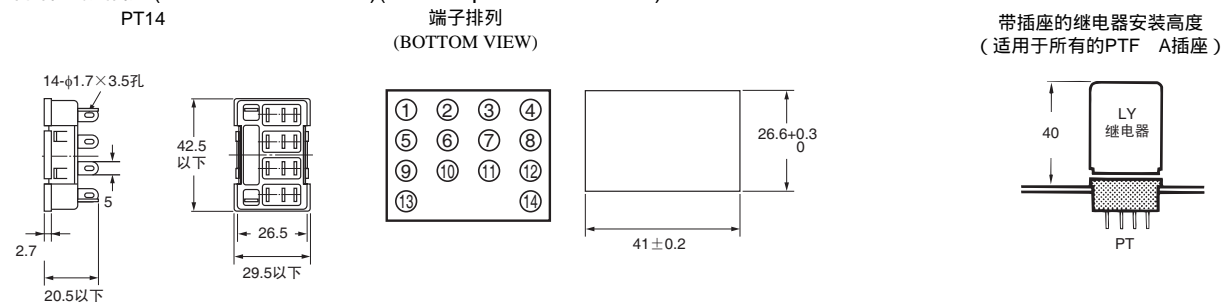

后端连接插座(UL File No. E87929)(CSA Report No.LR31928)

PT08-0

端子排列与PT08相同

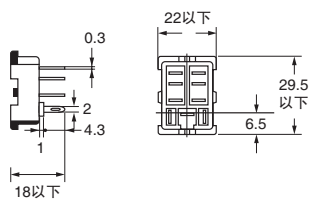

安装孔
(BOTTOM VIEW)

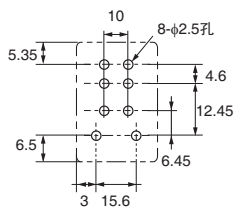

PT11-0

端子排列与PT11相同

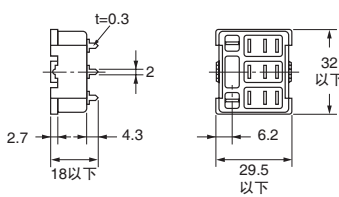

安装孔
(BOTTOM VIEW)

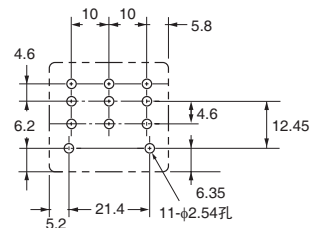

后端连接插座(UL File No. E87929)(CSA Report No.LR31928)

PT14-0

端子排列与PT14相同

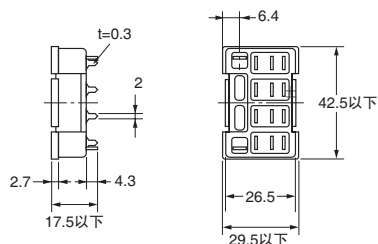

安装孔
(BOTTOM VIEW)

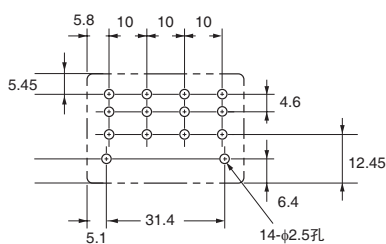

继电器保持夹子

PYC-A1

带PTF A插座

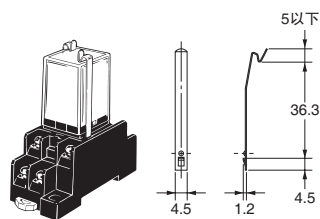

PYC-S

继电器安装片

(安装片仅适用于类型
PYP-1和PYP-18的插座)

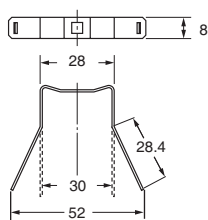
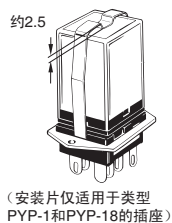

PYC-P

带PT 插座

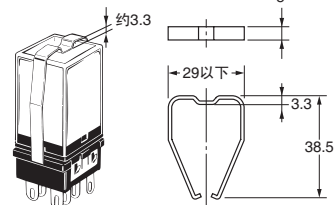

继电器

一般继电器

技术指南

后端连接插座的安装片

PYP-1

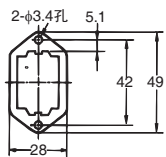

t=1.6

PTP-1-3

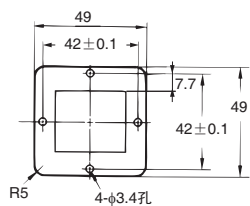

t=1.6

PTP-1

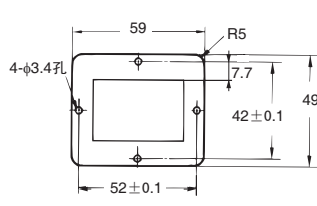

t=1.6

PYP-18

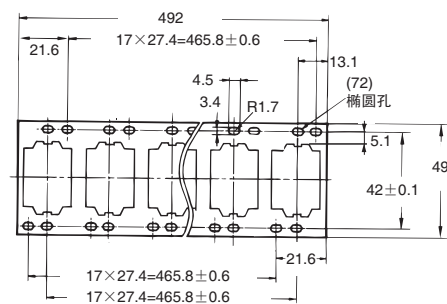

t=1.6

PTP-10

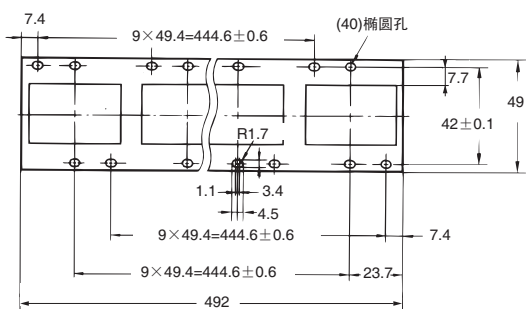

PTP-12

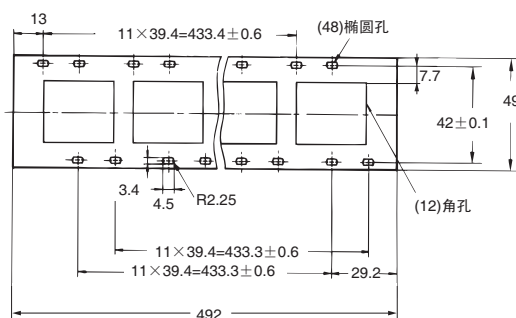

继电器

一般继电器

技术指南