

Digital Panel Meter K3TG

CSM_K3TG_DS_E_2_1

Subminiature Digital Panel Meter that Accepts DC Input

- Ultra-compact DIN-size (48 x 24 (W x H)) body.
- Mounting thickness of only 2 mm required.
- Highly visible display with 10.2-mm-high LEDs.
- 5-VDC power supply for control.
- IP51 waterproofing with accessory attached.

 Refer to *Safety Precautions for All Digital Panel Meters*.

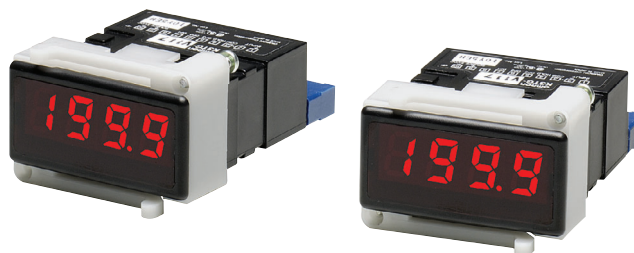

Model Number Structure

Model Number Legend

K3TG -
 1 2 3 4

1, 2. Input Code

- V1: ± 199.9 mV
- V2: ± 1.999 V
- V3: ± 19.99 V
- V4: ± 199.9 V

3. Series No.

- 1: Current series

4. Supply Voltage

- 7: 5 VDC (not internally insulated)

Ordering Information

List of Models

Range	Measuring ranges	Supply voltage
		5 VDC (not internally insulated)
DC voltage	± 199.9 mV	K3TG-V117
	± 1.999 V	K3TG-V217
	± 19.99 V	K3TG-V317
	± 199.9 V	K3TG-V417

Accessories (Order Separately)

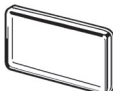
Name	Appearance	Model
Water-resistive Soft Front Cover		K32-L24SC

Specifications

■ Ratings

Supply voltage	5 VDC (not internally insulated)		
Operating voltage range	-5% to +5% of supply voltage		
Power consumption	0.3 W (at max. DC load)		
Insulation resistance	10 MΩ min. (at 500 VDC) between external terminal and case		
Dielectric strength	2,000 VAC min. for 1 min between external terminal and case		
Noise immunity	±200 V on power supply terminals in normal mode ±500 V on power supply terminals in common mode		
Vibration resistance	Malfunction: 10 to 55 Hz, 0.5-mm single amplitude for 10 min each in X, Y, and Z directions Destruction: 10 to 55 Hz, 0.75-mm single amplitude for 2 hrs each in X, Y, and Z directions		
Shock resistance	Malfunction: 98 m/s ² for 3 times each in 6 directions Destruction: 294 m/s ² for 3 times each in 6 directions		
Ambient temperature	Operating: -10° to 55°C (with no icing) Storage: -20° to 65°C (with no icing)		
Ambient humidity	Operating: 35% to 85% (with no condensation)		
Ambient operating atmosphere	No corrosive gas		
EMC	(EMI)	EN61326+A1	Industry
	Emission Enclosure:	CISPR 11 Group 1 class A: CISRP16-1/-2	
	Emission AC Mains:	CISPR 11 Group 1 class A: CISRP16-1/-2	
	(EMS)	EN61326+A1	Industry
	Immunity ESD:	EN61000-4-2:	4 kV contact discharge (level 2) 8 kV air discharge (level 3)
	Immunity RF-interference:	EN61000-4-3:	10 V/m (amplitude-modulated, 80 MHz to 1 GHz) (level 3)
	Immunity Fast Transient Noise:	EN61000-4-4:	2 kV (power line) (level 3)
	Immunity Burst Noise:		1 kV line to line (I/O signal line)
	Immunity Surge:	EN61000-4-5:	1 kV line to line 2 kV line to ground (power line)
	Immunity Conducted Disturbance	EN61000-4-6:	3 V (0.15 to 80 MHz) (level 2)
	Immunity Voltage Dip/Interrupting	EN61000-4-11:	0.5 cycles, 0, 180°, 100% (rated voltage)

■ Characteristics

Input signal	DC voltage
A/D conversion method	Double integral method
Sampling period	2.5 times/s
Display refresh period	2.5 times/s
Max. displayed digits	3 1/2 digits (+1999)
Display	7-segment red LED
Decimal point display position	By short-circuiting terminals
Sign display	"-" is displayed automatically with a negative input signal.
Overflow/underflow display	Overflow: #□□□ Underflow: - #□□□
Zero suppression	Not supported.
External control	Process value hold (terminals on rear panel short-circuited)
Degree of protection	Front panel: IEC IP51 (see note) Case: IEC IP20 Terminals: IEC IP00

Note: IP51 is maintained when the water-resistant soft cover and bracket are used. IP50 will be, however, maintained without these water-resistant accessories.

■ Measuring Ranges

Input range	Measuring range	Max. resolution	Input impedance	Accuracy	Max. permissible load
DC voltage	±199.9 mV	100 μV	100 MΩ	±0.1%rdg ±1 digit	±250 V
	±1.999 V	1 mV	100 MΩ	±0.1%rdg ±1 digit	±250 V
	±19.99 V	10 mV	10 MΩ	±0.1%rdg ±1 digit	±250 V
	±199.9 V	100 mV	10 MΩ	±0.1%rdg ±1 digit	±350 V

Note: The above accuracy is at an ambient temperature of 23±5°C.

Connections

External Connections

External Connection (Connector and connector screws are provided with the model.)

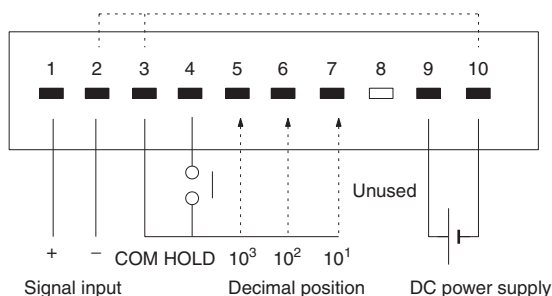

Conformance to EN/IEC Standards

To ensure conformance to EN/IEC standards in machinery that incorporates the K3TG, ensure that input signal lines are less than 30 m.

- Note:** 1. Terminals 2 and 3 and 10 are not internally insulated. Connect a relay with high contact reliability and insulation (with a minimum load current of 0.3 mA) or a photocoupler with high insulation (with a residual voltage of 1 V max. and a current leakage of 0.1 mA max.) to these terminals for external control. The use of an independent power supply is recommended for the Digital Panel Meter.
 2. Terminal 8 is not used. Do not use this terminal for transmission of signals.

Nomenclature



PV display

Select the decimal position with terminal 5, 6, or 7 on the rear panel.



Dimensions

Note: All units are in millimeters unless otherwise indicated.

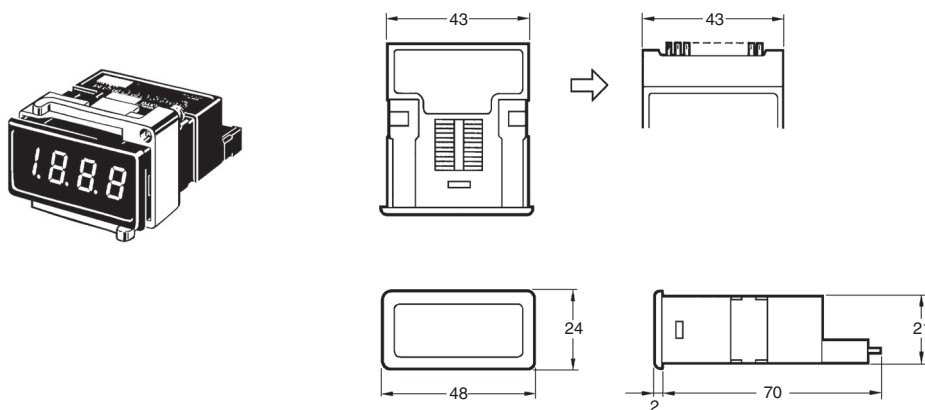

Panel Cutouts

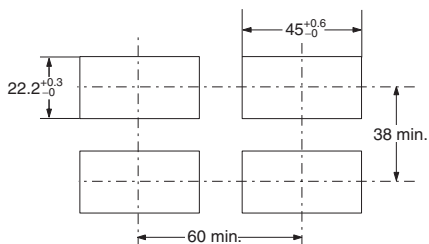

LED Indicator Size

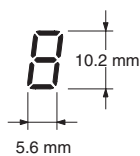

Note: The values above are recommended values. Do not group-mount the meters at intervals less than the recommended ones.

Application Examples

High DC Voltage Measurement

When voltage exceeding the maximum voltage in the standard range is measured (for example: more than 200 V), a divider is connected externally.

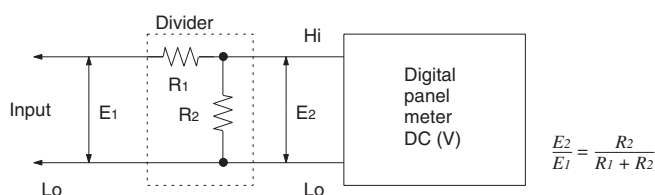

Safety Precautions

■ Precautions for Correct Use

Refer to *Safety Precautions for All Digital Panel Meters*.

Mounting

Recommended panel thickness is 1 to 3.2 mm.

Mount the Digital Panel Meter by attaching the mounting bracket supplied as an accessory from the rear of the Digital Panel Meter and hooking the mounting bracket to the Digital Panel Meter securely.

Tighten the mounting screws by turning them clockwise with a tightening torque of 4 kgf·cm (0.39 N·m).

To dismount the Digital Panel Meter, loosen the screws and widen the hooks.

Mount the Digital Panel Meter as horizontally as possible.

Calibration

Calibrate the Digital Panel Meter regularly so that the Digital Panel Meter can maintain processing accuracy.

Use a standard signal generator with an accuracy of 99.99% min. for calibration.

For the precise calibration methods, refer to the Instruction Sheet for the Digital Panel Meter.

Control Power Supply

Use a control power supply with a ripple rate of 10% max.

Accessories (Order Separately)

Water-resistant Soft Front Cover

Before mounting the Digital Panel Meter to a panel, attach the water-resistant soft front cover and mounting bracket to the Digital Panel Meter properly so that the Digital Panel Meter will maintain IP51 water-resistant standards.

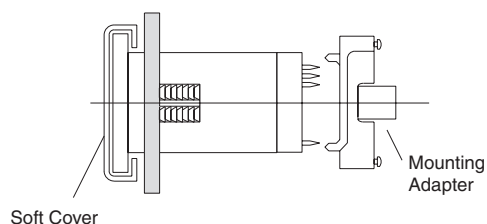

Note: Be sure to use the Water-resistant Soft Front Cover and mounting bracket together.

ALL DIMENSIONS SHOWN ARE IN MILLIMETERS.

To convert millimeters into inches, multiply by 0.03937. To convert grams into ounces, multiply by 0.03527.

In the interest of product improvement, specifications are subject to change without notice.

Terms and Conditions Agreement

Read and understand this catalog.

Please read and understand this catalog before purchasing the products. Please consult your OMRON representative if you have any questions or comments.

Warranties.

(a) Exclusive Warranty. Omron's exclusive warranty is that the Products will be free from defects in materials and workmanship for a period of twelve months from the date of sale by Omron (or such other period expressed in writing by Omron). Omron disclaims all other warranties, express or implied.

(b) Limitations. OMRON MAKES NO WARRANTY OR REPRESENTATION, EXPRESS OR IMPLIED, ABOUT NON-INFRINGEMENT, MERCHANTABILITY OR FITNESS FOR A PARTICULAR PURPOSE OF THE PRODUCTS. BUYER ACKNOWLEDGES THAT IT ALONE HAS DETERMINED THAT THE PRODUCTS WILL SUITABLY MEET THE REQUIREMENTS OF THEIR INTENDED USE.

Omron further disclaims all warranties and responsibility of any type for claims or expenses based on infringement by the Products or otherwise of any intellectual property right. (c) Buyer Remedy. Omron's sole obligation hereunder shall be, at Omron's election, to (i) replace (in the form originally shipped with Buyer responsible for labor charges for removal or replacement thereof) the non-complying Product, (ii) repair the non-complying Product, or (iii) repay or credit Buyer an amount equal to the purchase price of the non-complying Product; provided that in no event shall Omron be responsible for warranty, repair, indemnity or any other claims or expenses regarding the Products unless Omron's analysis confirms that the Products were properly handled, stored, installed and maintained and not subject to contamination, abuse, misuse or inappropriate modification. Return of any Products by Buyer must be approved in writing by Omron before shipment. Omron Companies shall not be liable for the suitability or unsuitability or the results from the use of Products in combination with any electrical or electronic components, circuits, system assemblies or any other materials or substances or environments. Any advice, recommendations or information given orally or in writing, are not to be construed as an amendment or addition to the above warranty.

See <http://www.omron.com/global/> or contact your Omron representative for published information.

Limitation on Liability; Etc.

OMRON COMPANIES SHALL NOT BE LIABLE FOR SPECIAL, INDIRECT, INCIDENTAL, OR CONSEQUENTIAL DAMAGES, LOSS OF PROFITS OR PRODUCTION OR COMMERCIAL LOSS IN ANY WAY CONNECTED WITH THE PRODUCTS, WHETHER SUCH CLAIM IS BASED IN CONTRACT, WARRANTY, NEGLIGENCE OR STRICT LIABILITY.

Further, in no event shall liability of Omron Companies exceed the individual price of the Product on which liability is asserted.

Suitability of Use.

Omron Companies shall not be responsible for conformity with any standards, codes or regulations which apply to the combination of the Product in the Buyer's application or use of the Product. At Buyer's request, Omron will provide applicable third party certification documents identifying ratings and limitations of use which apply to the Product. This information by itself is not sufficient for a complete determination of the suitability of the Product in combination with the end product, machine, system, or other application or use. Buyer shall be solely responsible for determining appropriateness of the particular Product with respect to Buyer's application, product or system. Buyer shall take application responsibility in all cases.

NEVER USE THE PRODUCT FOR AN APPLICATION INVOLVING SERIOUS RISK TO LIFE OR PROPERTY OR IN LARGE QUANTITIES WITHOUT ENSURING THAT THE SYSTEM AS A WHOLE HAS BEEN DESIGNED TO ADDRESS THE RISKS, AND THAT THE OMRON PRODUCT(S) IS PROPERLY RATED AND INSTALLED FOR THE INTENDED USE WITHIN THE OVERALL EQUIPMENT OR SYSTEM.

Programmable Products.

Omron Companies shall not be responsible for the user's programming of a programmable Product, or any consequence thereof.

Performance Data.

Data presented in Omron Company websites, catalogs and other materials is provided as a guide for the user in determining suitability and does not constitute a warranty. It may represent the result of Omron's test conditions, and the user must correlate it to actual application requirements. Actual performance is subject to the Omron's Warranty and Limitations of Liability.

Change in Specifications.

Product specifications and accessories may be changed at any time based on improvements and other reasons. It is our practice to change part numbers when published ratings or features are changed, or when significant construction changes are made. However, some specifications of the Product may be changed without any notice. When in doubt, special part numbers may be assigned to fix or establish key specifications for your application. Please consult with your Omron's representative at any time to confirm actual specifications of purchased Product.

Errors and Omissions.

Information presented by Omron Companies has been checked and is believed to be accurate; however, no responsibility is assumed for clerical, typographical or proofreading errors or omissions.